

H2 1 stk.
(borðsti.)

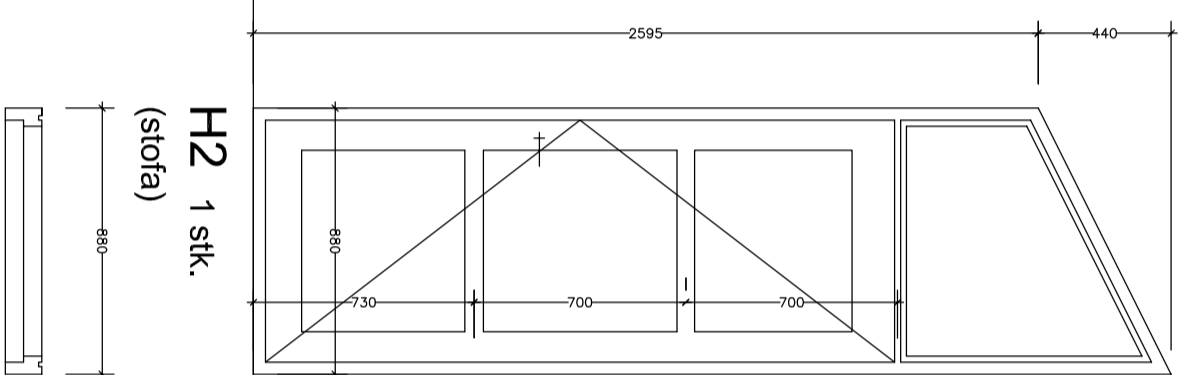

H2 1 stk.
(stofa)

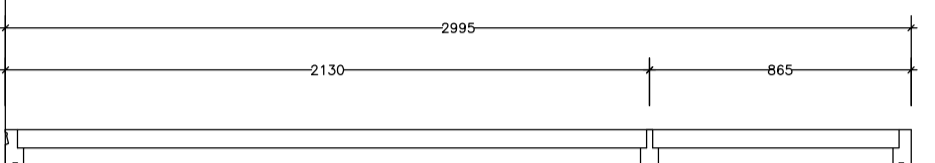
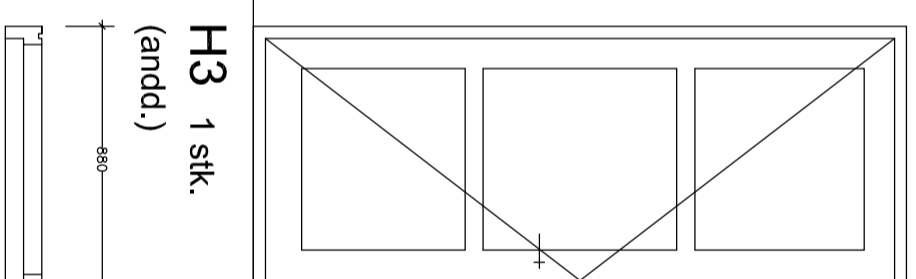
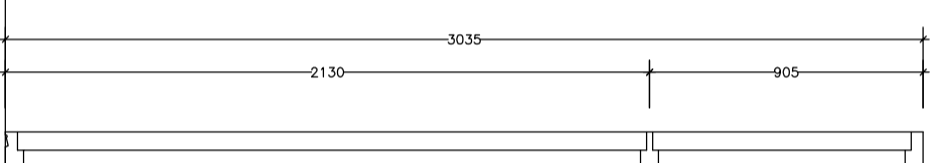

H3 1 stk.
(andd.)

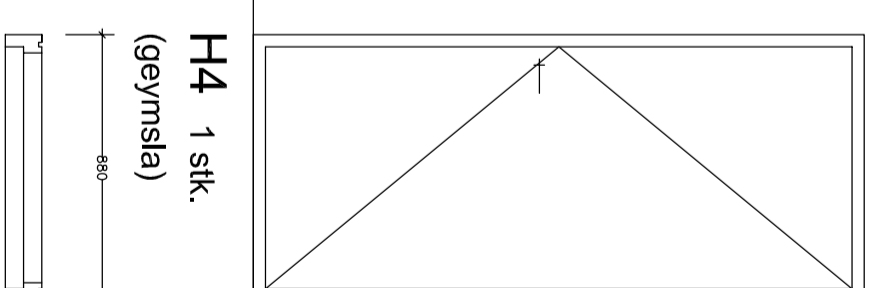
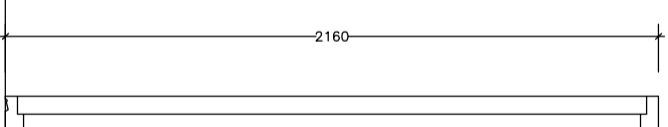

H4 1 stk.
(geymsla)

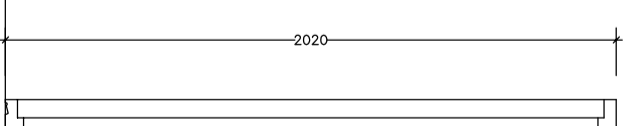

hagtaekni

tækniþjónusta

VERK
Retsholt 24, Skorradal

Retsholt 7, Skorradal

TRÉNAÐG
Sumarbústaður
Hundur 1/25

VERK.NR.
322

ÞÓMALAR
Ingólfur Margræsson 070252-3099

UNDRITUN
20. janúar 2010

TRÉNAÐG
107